

# CG2-3000A 2V 3000Ah(10hr)

The rechargeable batteries are lead-lead dioxide systems. The dilute sulfuric acid electrolyte is absorbed by separators and plates and thus immobilized. Should the battery be accidentally overcharged producing hydrogen and oxygen, special one-way valves allow the gases to escape thus avoiding excessive pressure build-up. Otherwise, the battery is completely sealed and is, therefore, maintenance-free, leak proof and usable in any position.



## Battery Construction

Component	Positive plate	Negative plate	Container	Cover	Safety valve	Terminal	Separator	Electrolyte
Raw material	Lead dioxide	Lead	ABS	ABS	Rubber	Copper	Fiberglass	Gelled acid

## General Features

- Absorbent Glass Mat (AGM) technology for efficient gas recombination of up to 99% and freedom from electrolyte maintenance or water adding.
- Not restricted for air transport-complies with IATA/ICAO Special Provision A67.
- UL-recognized component.
- Can be mounted in any orientation.
- Computer designed lead, calcium tin alloy grid for high power density.
- Long service life, float or cyclic applications.
- Maintenance-free operation.
- Low self discharge.

## Dimensions and Weight

Length(mm / inch)	710 / 27.95
Width(mm / inch)	350 / 13.78
Height(mm / inch)	345 / 13.58
Total Height(mm / inch)	382 / 15.04
Approx. Weight(Kg / lbs)	210 / 463.3

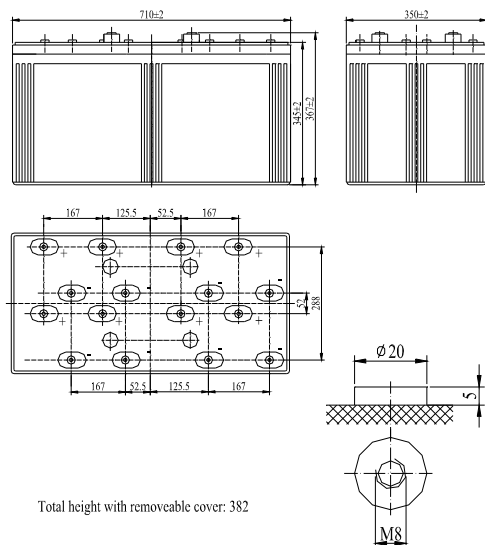

Total height with removable cover: 382

## Performance Characteristics

Nominal Voltage	2V
Number of cell	1
Design Life	20 years
Nominal Capacity 77°F(25°C)	
10 hour rate (300A, 1.8V)	3000Ah
5 hour rate (540A, 1.75V)	2700Ah
1 hour rate (1860A, 1.6V)	1860Ah
Internal Resistance	
Fully Charged battery 77°F(25°C)	≤ 0.5mOhms
Self-Discharge	
3% of capacity declined per month at 20°C(average)	
Operating Temperature Range	
Discharge	-20~60°C
Charge	-10~60°C
Storage	-20~60°C
Max. Discharge Current 77°F(25°C)	7000A(5s)
Charge Methods: Constant Voltage Charge 77°F(25°C)	
Cycle use	2.40-2.45VPC
Maximum charging current	600A
Temperature compensation	-5.0mV/°C
Standby use	2.20-2.30VPC
Temperature compensation	-3.3mV/°C

## Discharge Constant Current (Amperes at 77°F25°C)

End Point Volts/Cell	10min	15min	30min	45min	1h	3h	5h	10h
1.60V	5165	4033	2989	2173	1860	836	582	321
1.65V	4896	3839	2857	2086	1803	809	570	318
1.70V	4617	3639	2720	1994	1747	785	560	313
1.75V	4331	3436	2579	1898	1688	750	540	307
1.80V	4041	3230	2434	1800	1642	717	530	300

## Discharge Constant Power (Watts at 77°F25°C)

End Point Volts/Cell	10min	15min	30min	45min	1h	2h	3h	5h
1.60V	7748	6050	4484	3477	2976	2040	1423	922
1.65V	7344	5759	4286	3338	2895	2017	1386	906
1.70V	6926	5459	4088	3199	2814	1942	1346	888
1.75V	6497	5154	3890	3060	2733	1859	1302	869
1.80V	6062	4845	3692	2921	2652	1770	1268	826

(Note)The above characteristics data are average values obtained within three charge/discharge cycles not the minimum values. All data shall be changed without notice,Vision reserves the right to explain and update the information contained hereinto.

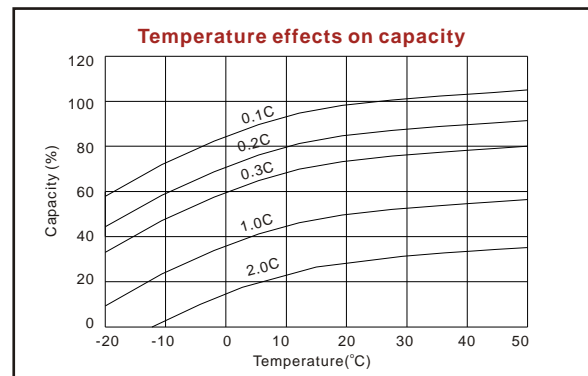
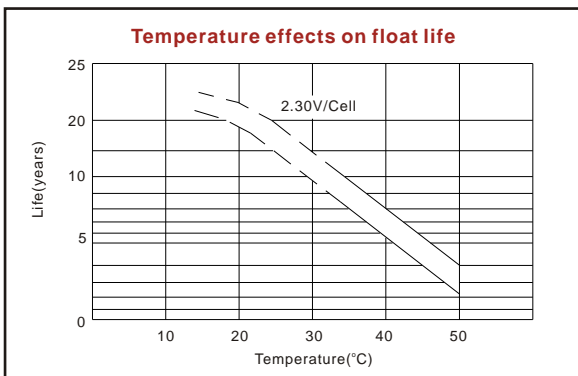
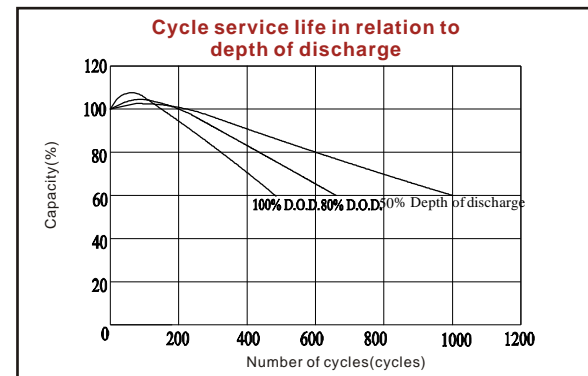
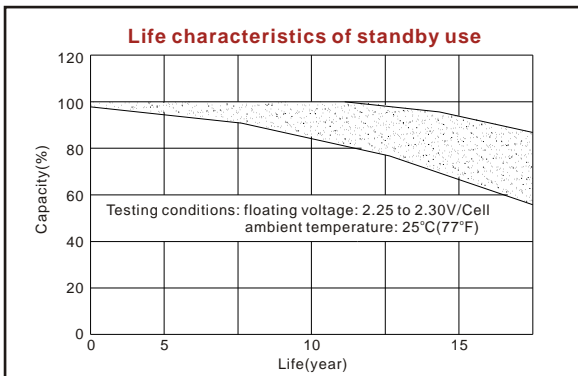
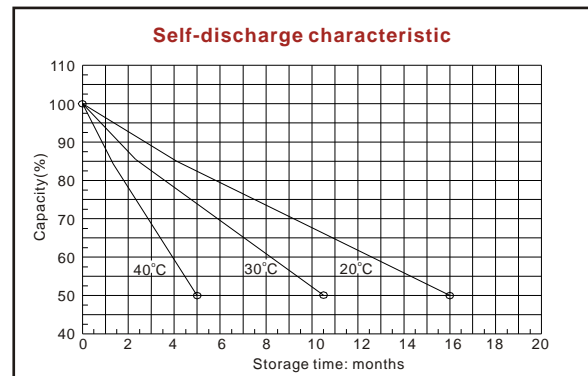
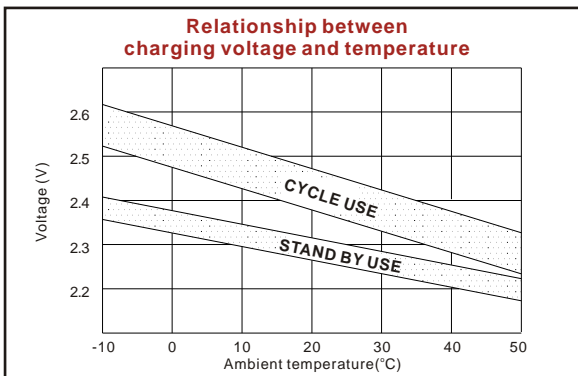
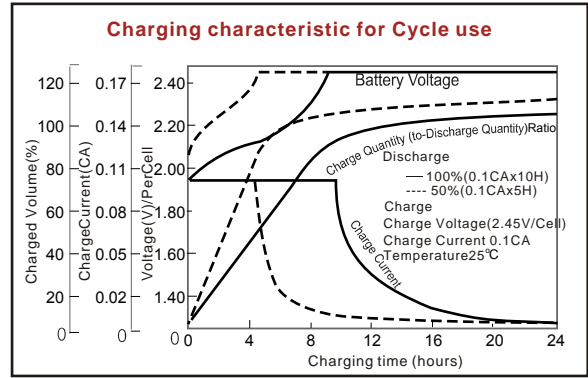
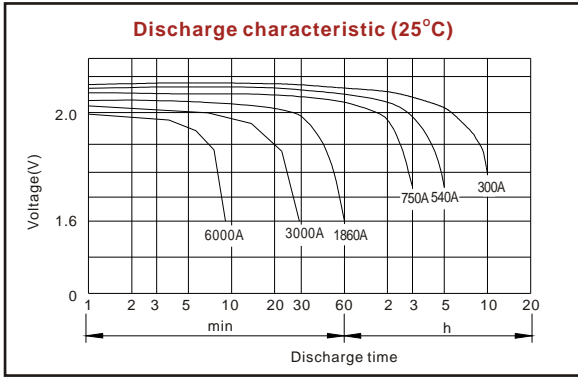

ISO9001:2008

MH25860

G4M19906-9202-E-16

[www.vision-batt.com](http://www.vision-batt.com)

**Shenzhen Center Power Tech. Co., Ltd.**  
 Center Power Industrial Park, Tongfu Industrial District Dapeng Town, 518120 Shenzhen, China  
 Tel: (+86-755) 8431 8088 Fax: (+86-755) 8431 8038 E-mail: sales@vision-batt.com