



VISION GROUP
Shenzhen Center Power
Tech.Co.Ltd.,

HFS12-820WS-X

12V 220Ah

Overview

The new VISION HFS series batteries are designed for UPS Standby Power Applications requiring high power output. Computer designed grids and optimized plate paste formula produce high energy density and long lasting uninterrupted power for critical systems.



Battery Construction

Component	Positive plate	Negative plate	Container	Cover	Safety valve	Terminal	Separator	Electrolyte
Raw material	Lead dioxide	Lead	ABS	ABS	Rubber	Copper	Fiberglass	Sulfuric acid

General Features

- Positive and negative plates in lead-calcium-tin alloy;
- Superior energy density;
- Operate at a low internal pressure;
- Gas recombination;
- Special separator technology;
- A recognized component of UL, IEC, TLC. etc;
- Flame retardant ABS(UL 94-FV0);
- Very high power output for 5 to 15 minutes supply
- A covered range from 90W to 850W per cell for 15min @ 1.67Vpc;
- Six months shelf life at 20 °C;
- Design life :12+ years at 20 °C;
- Recommended loading 1h and below;

Battery Specification

Performance Characteristics	
Nominal Voltage	12V
Number of cell	6
Design Life	12 years
Nominal Capacity 77°F(25°C)	
15 min wattage @ 1.67VPC	820W/cell
10 hour rate (22.0A,10.8V)	220Ah
20 hour rate (11.5A,10.8V)	230Ah
Internal Resistance	
Fully Charged battery 77°F(25°C)	≤2.2 mOhms
Self-Discharge	
3% of capacity declined per month at 20°C(average)	
Operating Temperature Range	
Discharge	-20-60°C
Charge	-10-60°C
Storage	-20-60°C
Max. Discharge Current 77°F(25°C)	1100A(5s)
Charge Methods: Constant Voltage Charge 77°F(25°C)	
Cycle use	2.40-2.45VPC
Maximum charging current	69A
Temperature compensation	-30mV/°C
Standby use	2.23-2.30VPC
Temperature compensation	-20mV/°C

Dimensions and Weight

Length(mm / inch)	522/20.5
Width(mm / inch)	238/9.37
Height(mm / inch)	218/8.6
Total Height(mm / inch)	223/8.8
Approx. Weight(Kg / lbs)	67.5/148.9

* Weight deviation: ± 5%

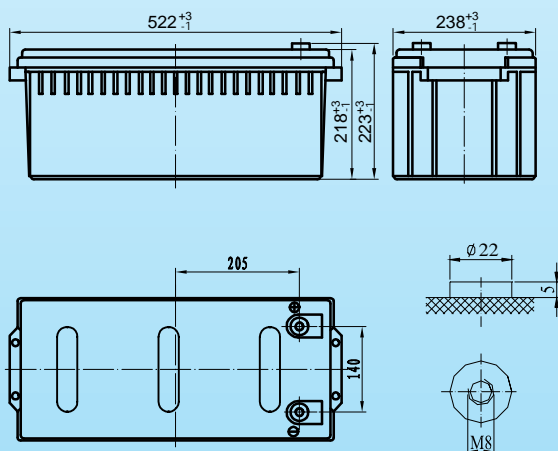

Discharge Constant Current (Amperes at 77°F25°C)

End Voltage Volts/Cell	3min	5min	10min	15min	20min	25min	30min	45min	60min
1.60V	940	748	558	447	389	341	303	222	171
1.65V	931	721	544	433	377	332	294	215	167
1.67V	915	711	538	428	372	328	291	212	165
1.70V	882	695	511	409	355	312	279	204	159
1.75V	876	675	486	390	337	296	267	194	151
1.80V	862	643	465	381	320	281	254	185	145

Discharge Constant Power (Watts at 77°F25°C)

End Point Volts/Cell	3min	5min	10min	15min	20min	25min	30min	45min	60min
1.60V	1486	1276	1018	827	683	601	534	394	305
1.65V	1451	1265	997	822	671	584	523	386	299
1.67V	1437	1261	984	820	667	578	519	383	297
1.70V	1402	1200	966	780	645	554	504	373	289
1.75V	1376	1138	907	752	621	531	488	362	281
1.80V	1347	1114	857	680	578	508	463	352	273

(Note)The above characteristics data are average values obtained within three charge/discharge cycles not the minimum values.All data shall be changed without notice,Vision reserves the right to explain and update the information contained hereinto.



VISION GROUP
Shenzhen Center Power
Tech.Co.Ltd.,

HFS12-820WS-X

12V 220Ah

