

CG12-200PEX 12V 200Ah(10hr)

Gel battery shows some distinctive advantages over flooded battery or AGM battery, such as super thermal stability, high deep discharge capability, good recovery from deep discharge, even if the battery is left discharged for three days, it will recover to 100% of capacity. With the above-mentioned advantages, the gel battery has long service life, specially suitable for motive power applications, such as golf trailer, sruubber, folklift, etc. The deep discharge cycles increased 50% as compared with the AGM battery.

Battery Construction

Component	Positive plate	Negative plate	Container	Cover	Safety valve	Terminal	Separator	Electrolyte
Raw material	Lead dioxide	Lead	ABS	ABS	Rubber	Copper	PE	Gelled acid

General Features

- Nanometer SiO₂ and H₂SO₄ gelled electrolyte technology for efficiency gas recombination of up to 99% and freedom from electrolyte maintenance or water adding.
- Not restricted for air transport-complies with IATA/ICAO Special Provision A67.
- UL-recognized component.
- Can be mounted in any orientation.
- Computer designed lead, calcium tin alloy grid for high power density.
- Long service life, float or cyclic applications.
- Maintenance-free operation.
- Low self discharge.
- Case and cover available in both standard and flame retardant ABS.

Dimensions and Weight

Length(mm / inch)	520 / 20.47
Width(mm / inch)	269 / 10.59
Height(mm / inch)	203 / 7.99
Total Height(mm / inch)	208 / 8.19
Approx. Weight(Kg / lbs)	68.0 / 149.9

* Weight deviation: ± 3%

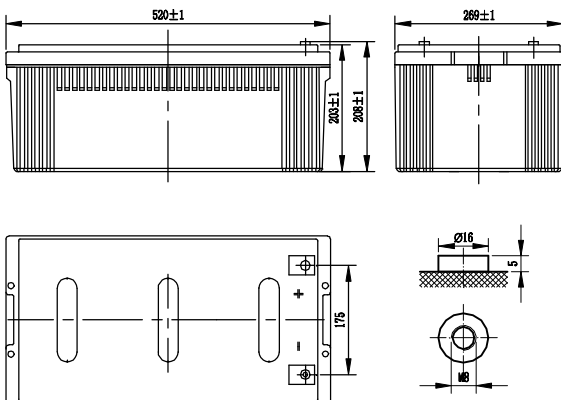

Performance Characteristics

Nominal Voltage	12V
Number of cell	6
Design Life	12 years
Nominal Capacity 77°F(25°C)	
10 hour rate (20.0A, 10.8V)	200Ah
5 hour rate (35.2A, 10.5V)	176Ah
1 hour rate (124A, 9.6V)	124Ah
Internal Resistance	
Fully Charged battery 77°F(25°C)	≤ 4.5mOhms
Self-Discharge	
2% of capacity declined per month at 20°C(average)	
Operating Temperature Range	
Discharge	-20~60°C
Charge	-10~60°C
Storage	-20~60°C
Max. Discharge Current 77°F(25°C)	1000A(5s)
Short Circuit Current	3000A
Charge Methods: Constant Voltage Charge 77°F(25°C)	
Cycle use	2.40-2.45VPC
Maximum charging current	60.0A
Temperature compensation	-20mV/°C
Standby use	2.27-2.30VPC
No charge current limit is required	
Temperature compensation	-30mV/°C

Discharge Constant Current (Amperes at 77°F25°C)

End point volts/cell	10min	15min	30min	1h	3h	5h	10h	20h
1.60V	420	344	200	124	52.0	38.0	21.0	11.2
1.65V	396	320	196	120	50.7	36.8	20.7	11.0
1.70V	372	304	192	116	49.3	36.0	20.4	10.8
1.75V	348	280	188	112	48.7	35.2	20.2	10.7
1.80V	324	256	180	106	46.7	34.0	20.0	10.5

Discharge Constant Power (Watts at 77°F25°C)

End point volts/cell	10min	15min	30min	1h	3h	5h	10h	20h
1.60V	719	583	374	232	97.3	73.0	40.7	22.0
1.65V	684	579	358	221	92.4	68.9	38.5	20.8
1.70V	667	554	341	212	87.6	65.7	36.2	19.9
1.75V	634	520	331	204	83.3	64.2	34.9	19.2
1.80V	601	492	317	195	78.4	59.8	32.6	18.5

(Note)The above characteristics data are average values obtained within three charge/discharge cycles not the minimum values.
All data shall be changed without notice, Vision reserves the right to explain and update the information contained hereinto.

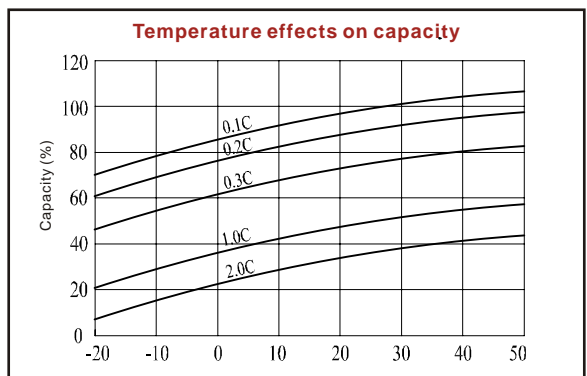
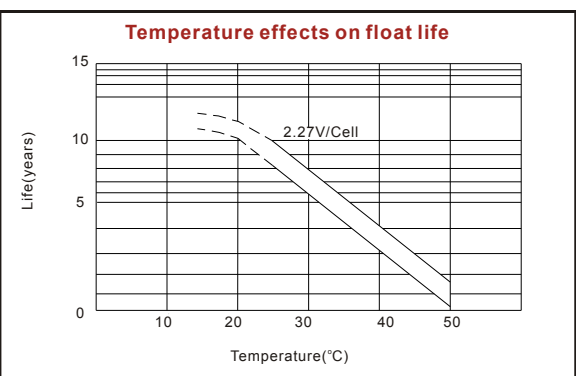
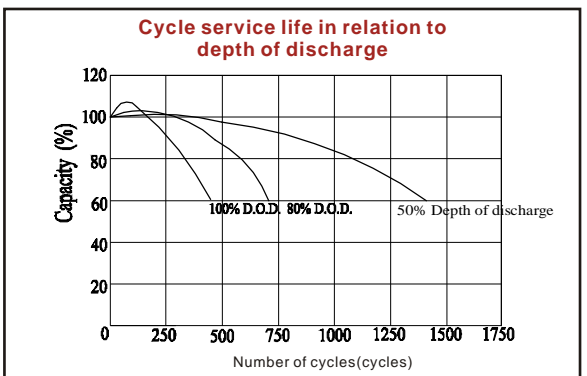
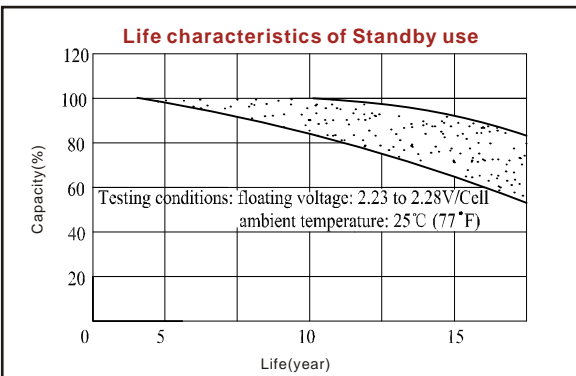
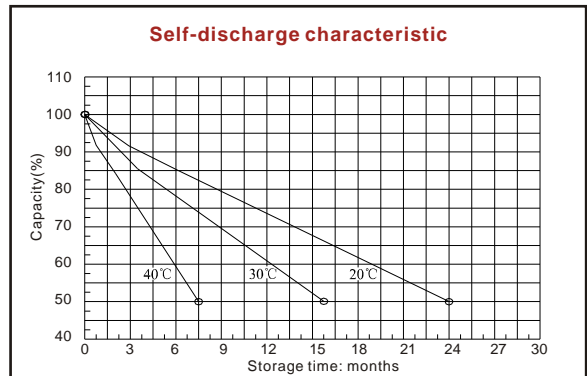
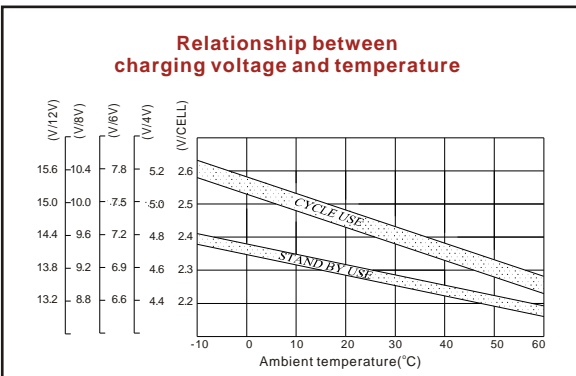
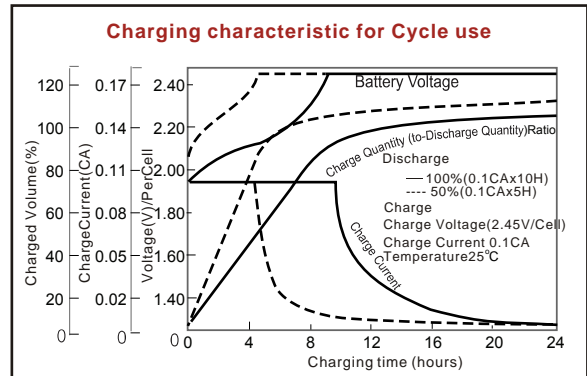
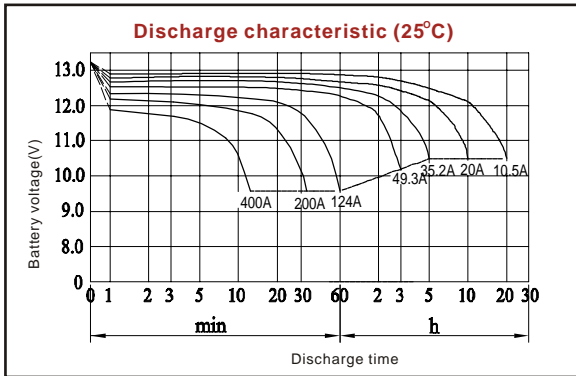

ISO9001:2008

MH25860

G4M19906-9202-E-16

www.vision-batt.com

Shenzhen Center Power Tech. Co., Ltd.
 Center Power Industrial Park, Tongfu Industrial District Dapeng Town, 518120 Shenzhen, China
 Tel: (+86-755) 8431 8088 Fax: (+86-755) 8431 8038 E-mail: sales@vision-batt.com